

## LEIKKURIT

Koneet on varustettu sisäänrakennetulla ilmansulkuventtiilillä.

Huom! Leikkurit toimitetaan ilman leikkuuterää. Katso terä viereisellä sivulla olevasta teräerittelystä.

MR20



MR30A



MP35A



MP250



MP55A



MOS20 Lukkorengaskone

Ulkopuoliset lukkorengaat  $\varnothing$  24-48

Sisäpuoliset lukkorengaat  $\varnothing$  25-63



Tuotekoodi	Leikkuuteho mm lanka $\varnothing$				Leikkuuvoima terän keskellä	Ilmantarve	Käyttö- paine	Pituus	Laitteen	Paino ilman terää	Äänenpai- netaso	Tärinä- taso
	kupari	teräs	piano	muovi pehmeä/kova								
MR20	2,6	2,0	1,0	7,0/5,0	140	0,23	5-6	155	45	0,34	83	1,3
MR30A	3,3	2,8	1,2	10,0/6,5	280	0,58	5-6	191	56	0,52	87	1,8
MP35A	4,8	4,0	1,2	13,0/6,5	450	0,95	5-6	268	56	0,83	88	1,8
MP55A	7,0	6,0	2,0	11,0/8,0	790	2,67	5-6	372	75	2,0	91	1,8
MP250	4,0	3,2	1,2	8,0/6,5	280	0,50	5-6	234	45	0,56	83	1,3
MOS20	-	-	-	-	-	0,23	5-6	140	45	0,29	83	1,5

**PSH10**

Erikoisleikkuri pellin, kumin, hartsin, mattojen ym. leikkaamiseen



Vakiovaruste: 242-E300S



Lisävaruste: 242-E300

Tuotekoodi	Leikkuuteho mm			Ilmantarve l/min	Leikkunopeus /min	Pituus mm	Laitteen Ø mm	Paino ilman terää kg	Äänenpainetaso dB (A)	Tärinätaso m/s <sup>2</sup>
	alumiini	teräs	Muovit, tiivisteaineet ym.							
PSH10	1,2	1,2	2,5	0,450	1 900	225	40	0,123	83,4	3,5
		E300S terä	E300 terä							

Tyyppi	Terä tuotekoodi 242-	Leikkuuteho mm			
		Kupari	Teräs	Pianolanka	Muovi
MR10	S4	1,6	1,0		
MR20	CR6	2,6	2,0		
	EP6	2,6	2,0		
	F5				7,0
MR30A	P6	2,6	2,0		
	Z6	2,6	2,0	1,0	
	CR8P	3,3	2,8		
	EP10P	3,3	2,8		
MP35A	FD9P				10,0
	F9P				10,0
	F9PS				10,0
	P8P	3,3	2,8		
	Z8P	3,3	2,8	1,2	
MP55A	CR8P	4,8	4,0		
	EP10P	4,8	4,0		
	FD9P				13,0
	F9P				13,0
	F9PS				10,0
MP250	P8P	4,8	4,0		
	CR120	7,0	6,0		
MOS20	P120	7,0	6,0		
	P8P1	4,0	3,2		
	R048	ulkopuoliset lukkorenkkaat Ø 24-48			

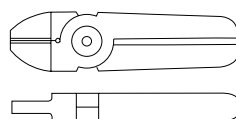
**CR-malli**

Kupari, teräs, sama kuin P-malli, mutta ohennetut leuat

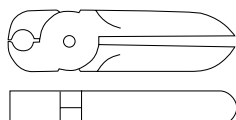
**EP-malli**

Päätyleikkuri, kupari, teräs

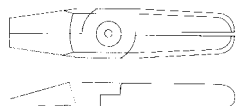
**F-malli**

Muovin leikkaamiseen

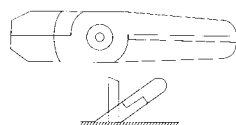
**FD-malli**

Muovin leikkaamiseen

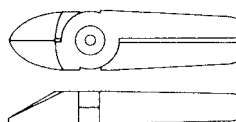
**S-malli**

Kupari, teräs

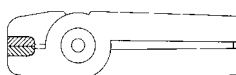
**Z-malli**

Kovametallileuat, kupari, teräs, pianolanka

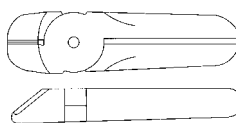
**P-malli**

Kupari, teräs

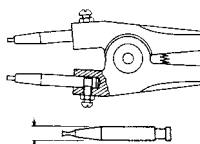
**RO-malli**

Terä lukkorenkkaalle MOS20

F-mallin terä



Teline

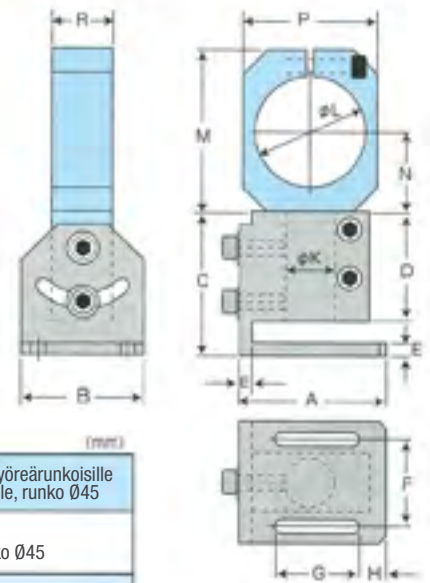

Mitat

Tuotekoodi 242-	Paino	A	B	C	D	E	F	G	H	J	K	L	M	N	P	R	S	Sopivuus pyöreärunkoisille leikkuriteille, runko Ø45
SVM 20	325g	60	50	59	45	5	36	34	11	90°	20	45.1	67	33	55	24	15	MR20M sarjan runko Ø45
SVM 30	367g	60	50	59	45	5	36	34	11	90°	20	56.1	78	38	70	24	15	MR30A sarjan runko Ø56

3-porttinen poljinventtiili

Teline

MR20, MR30A, MP35A

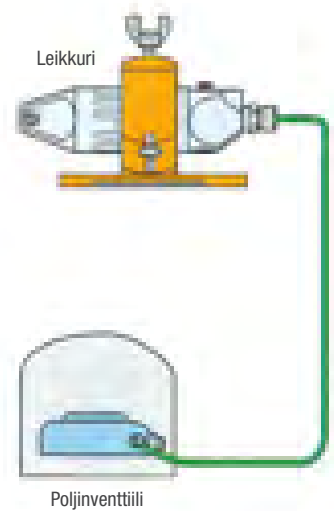
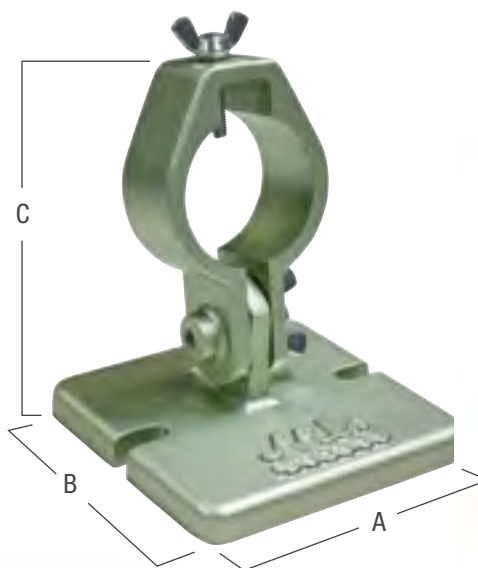
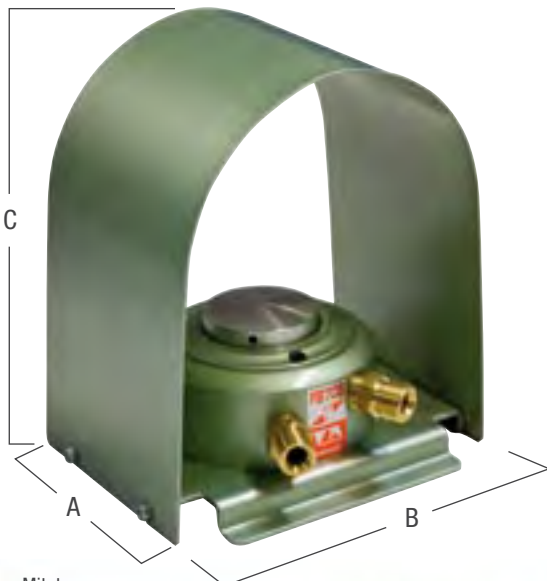

Mitat

Tuotekoodi 242-	Paino	A	B	C	Sopii koneille
FB70S	970 g	110 mm	122 mm	145 mm	
CTD20	600 g	140 mm	120 mm	118 mm	MR20
CTD30	500 g	140 mm	120 mm	118 mm	MR30A MP35A